

Chapter 4 : " Advanced Information "

This chapter describes more information about your Disk Array. The following items are describes in detail.

- Memory Expansion
- RAID Controller
- Updating Firmware
- Capacity Expansion (On-Line Expand)

Memory Expansion

Your Disk Array comes with 64MB of memory that is expandable to a total of 128MB by installing additional memory modules. The optional memory expansion socket is provided for installing memory module. These expansion memory module can be purchased from your dealer.

- Memory Type : 60NS STD 144pin DIMMs (SDRAM).
- Memory Size : Supports 144pin DIMMs of 64MB, or 128MB

Do not use DIMM modules which have an extra logic chip that has been used to convert the memory module from asymmetric to symmetric.

- Installing Memory Modules :

1. Unscrew & Remove cover

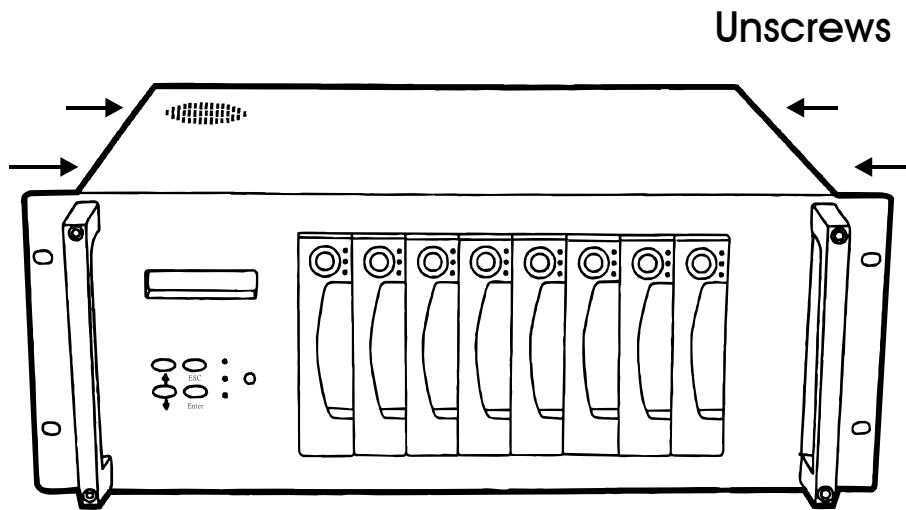

Figure : Remove Cover

2. Install the memory

- a. The DIMM memory modules will only fit in one orientation.
- b. Press the memory module firmly into socket from a 45 degree angle, make sure that all the contacts are aligned with the socket.
- c. Push the memory module forward to a horizontal position.

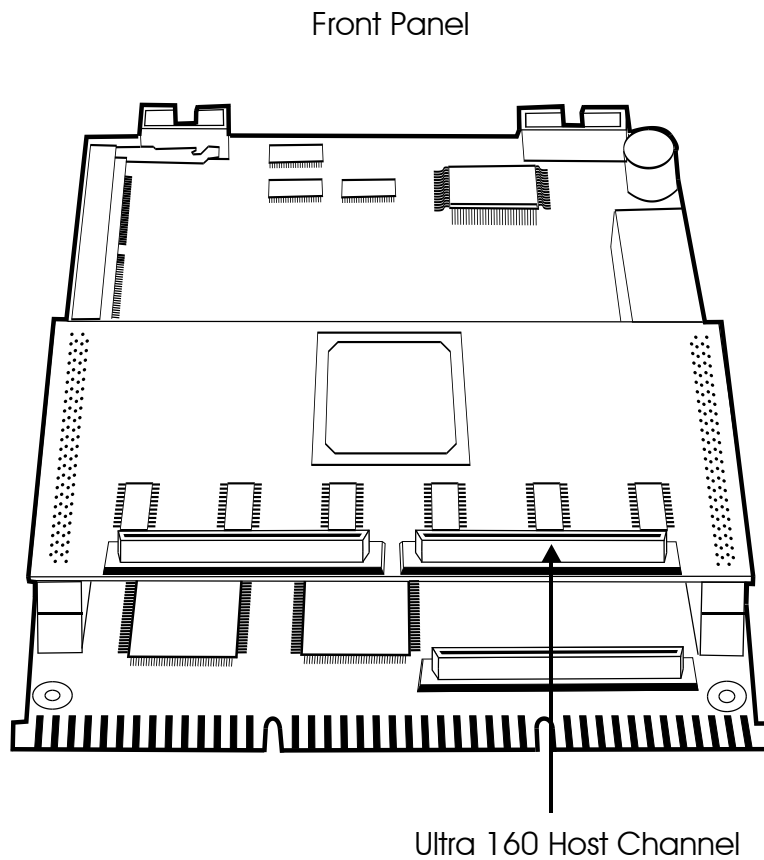
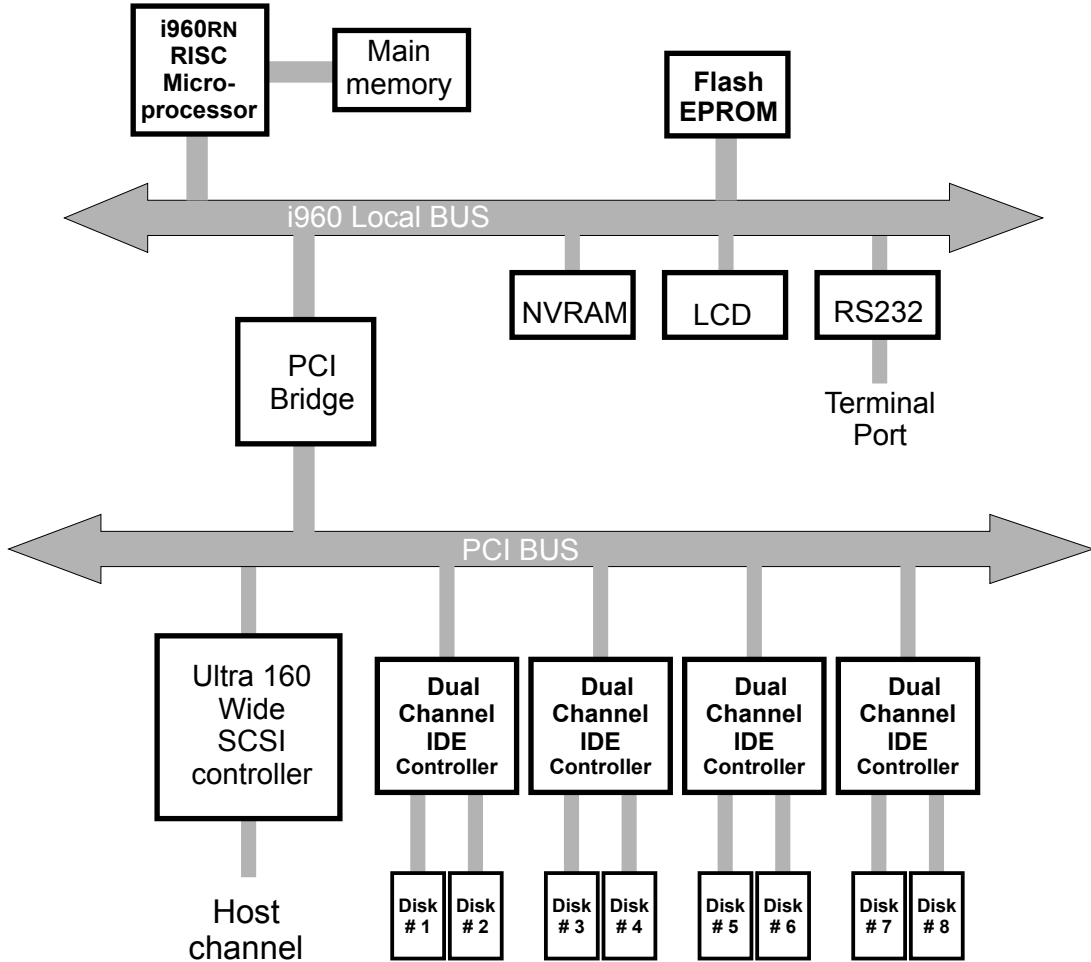

Figure : Controller

Disk Array Controller Block Diagram



Updating Firmware

1. Setup your VT100 Terminal

Please configure the VT100 terminal setting to the values shown below :

VT100 terminal (or compatible) set up

Connection	Serial Port (COM1 or COM2)
Protocol	RS232 (Asynchronous)
Cabling	Null-Modem cable
Baud Rate	115,200
Data Bits	8
Stop Bit	1
Parity	None

Setup VT100 Terminal

Example : Setup VT100 Terminal in Windows® 95

Step 1.

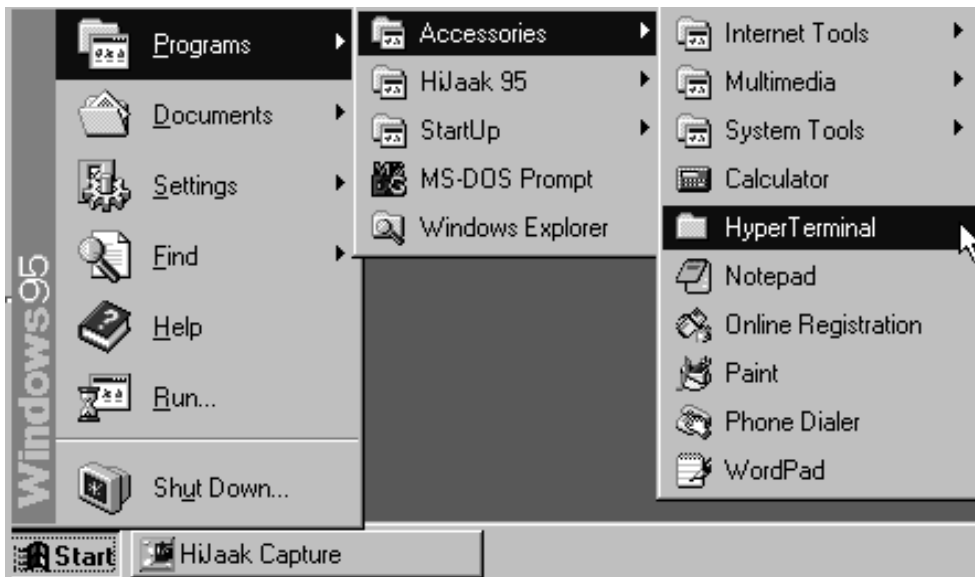

Step 2.

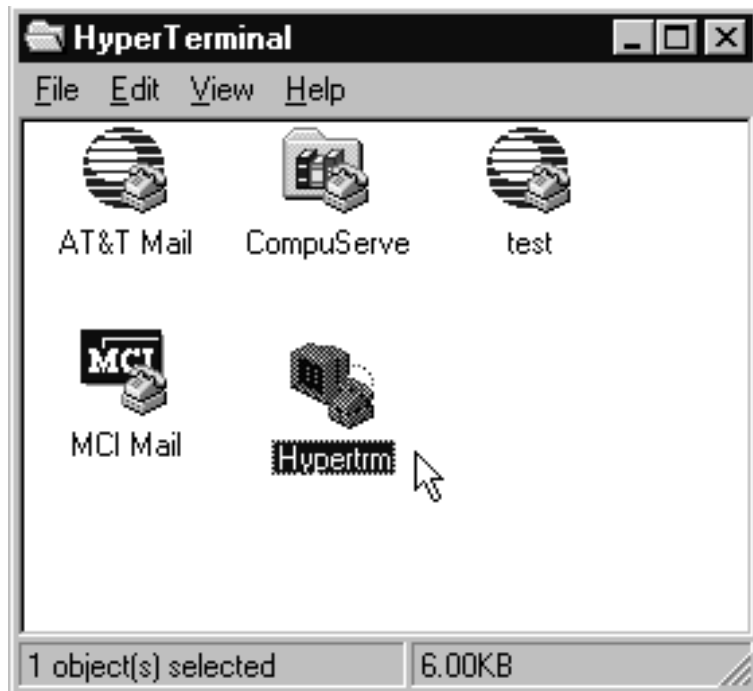

Advanced Information

Step 3. Enter a name for your Terminal.

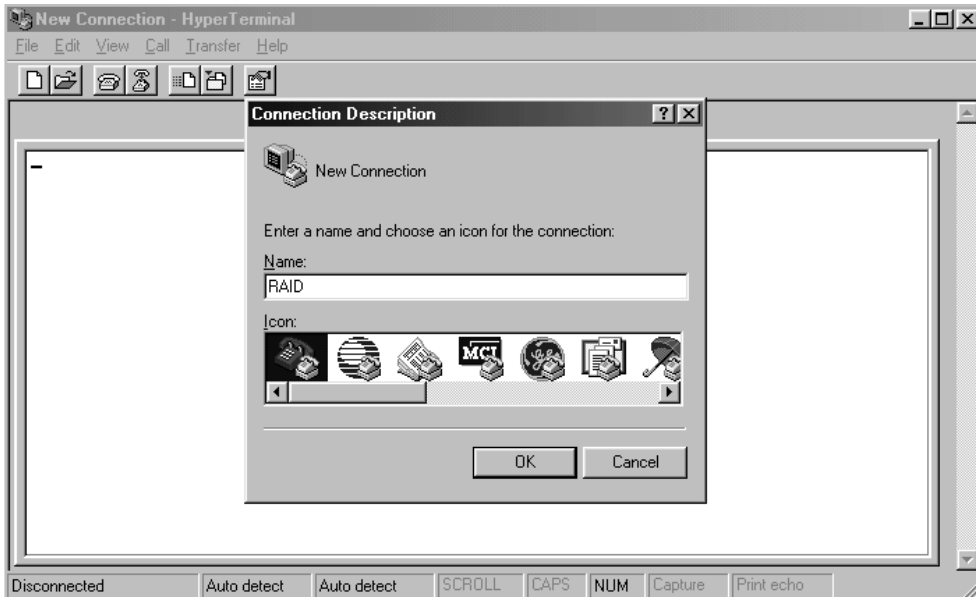

Advanced Information

Step 4. Select a connecting port in your Terminal.

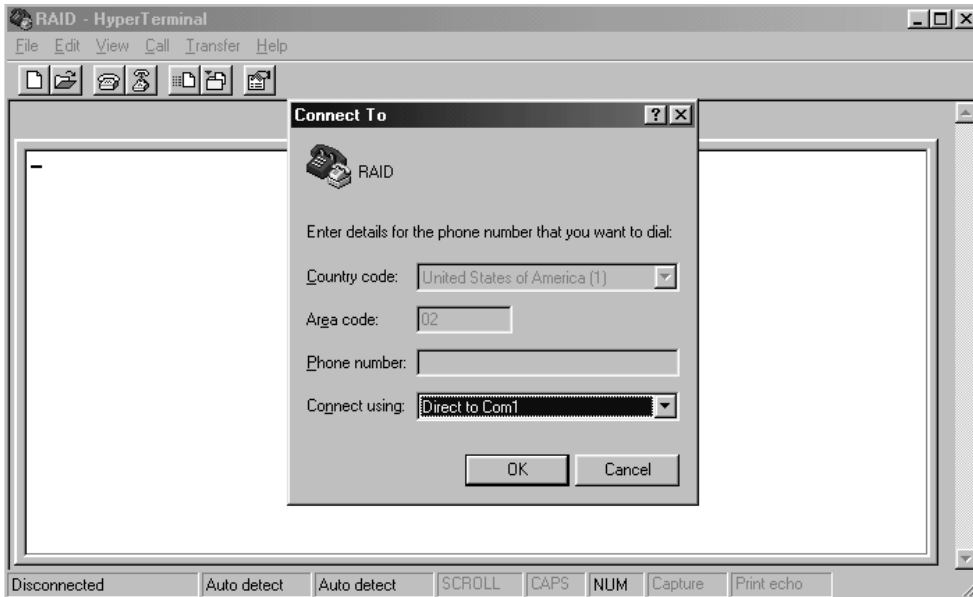

Advanced Information

Step 5. Port parameter settings

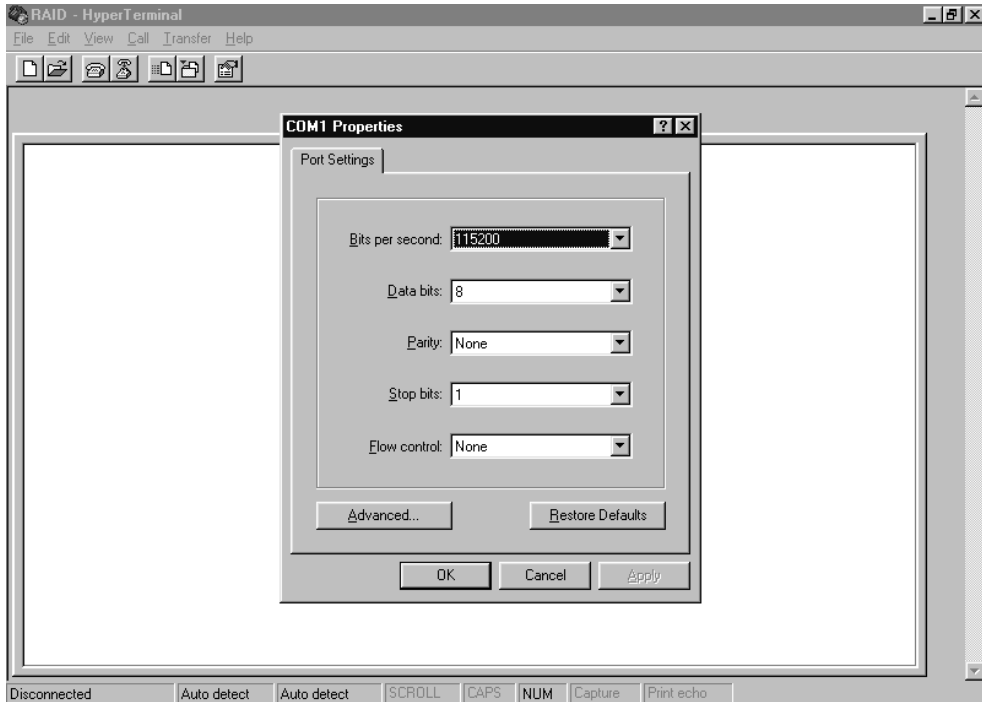

Step 6.

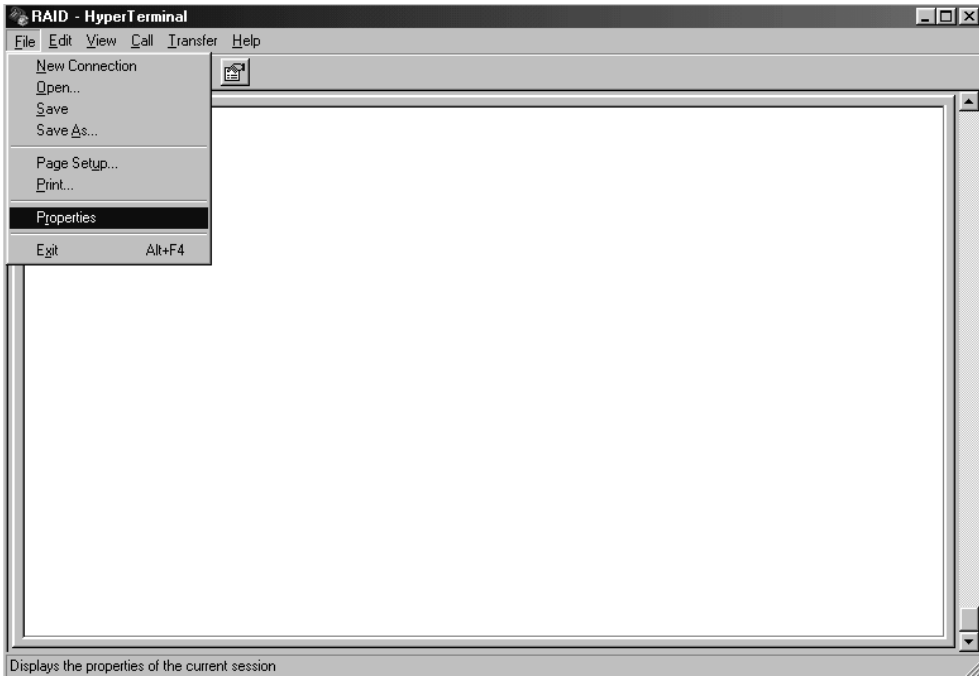

Step 7. Select emulate VT100 mode

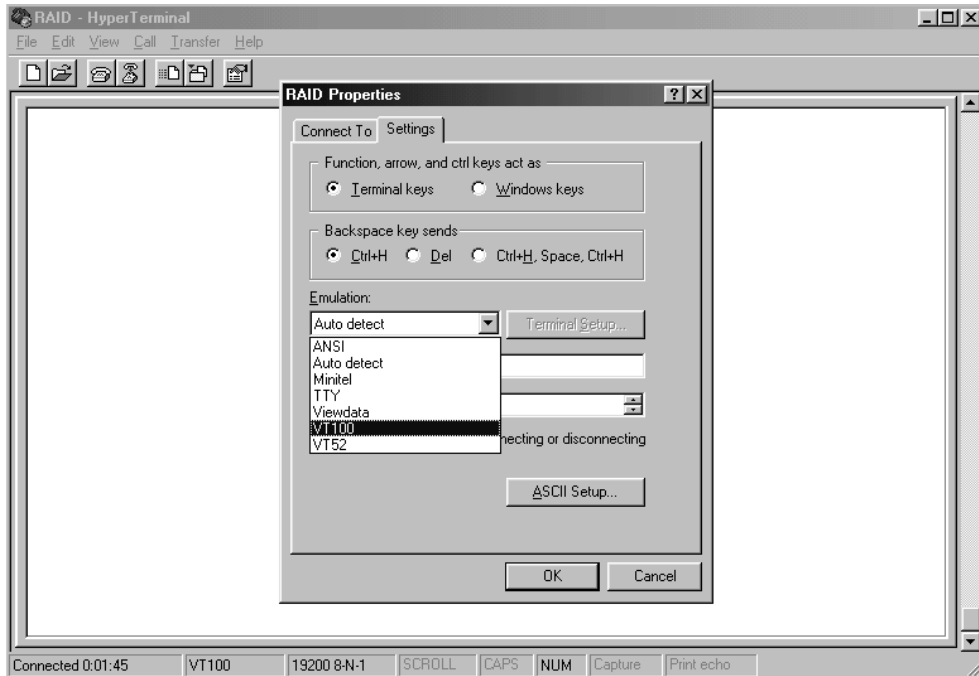

After you have finished the VT100 Terminal setup, you may restart your Disk Array and press " Ctrl + D " keys (in your Terminal)to link the Disk Array and Terminal together.

Press Ctrl + D to display the disk array Monitor Utility screen on your VT100 Terminal.

Start to Update Firmware

1. Move the cursor to " Update ROM " and press "Enter".

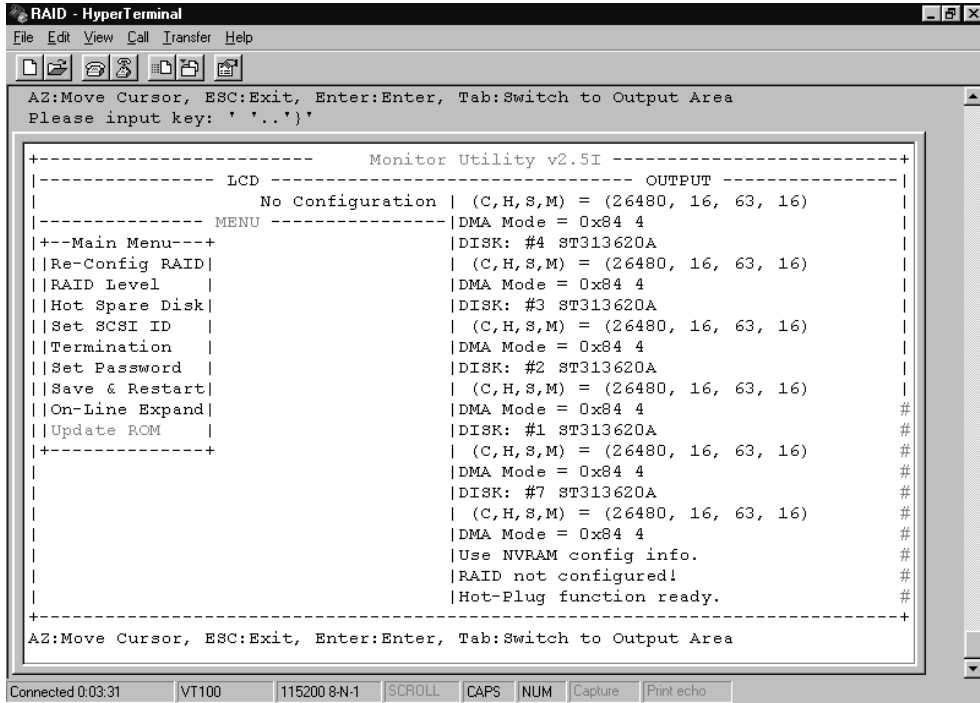

```
RAID - HyperTerminal
File Edit View Call Transfer Help
AZ:Move Cursor, ESC:Exit, Enter:Enter, Tab:Switch to Output Area
Please input key: ' '..'

+-----+
|-----+ Monitor Utility v2.5I +-----+
|-----+ LCD +-----+ OUTPUT +-----+
|-----+ No Configuration | (C,H,S,M) = (26480, 16, 63, 16)
|-----+ MENU +-----+ DMA Mode = 0x84 4
|+---Main Menu---+ |DISK: #4 ST313620A
||Re-Config RAID| | (C,H,S,M) = (26480, 16, 63, 16)
||RAID Level | |DMA Mode = 0x84 4
||Hot Spare Disk| |DISK: #3 ST313620A
||Set SCSI ID | | (C,H,S,M) = (26480, 16, 63, 16)
||Termination | |DMA Mode = 0x84 4
||Set Password | |DISK: #2 ST313620A
||Save & Restart| | (C,H,S,M) = (26480, 16, 63, 16)
||On-Line Expand| |DMA Mode = 0x84 4 #
||Update ROM | |DISK: #1 ST313620A #
|+-----+ | (C,H,S,M) = (26480, 16, 63, 16) #
| |DMA Mode = 0x84 4 #
| |DISK: #7 ST313620A #
| | (C,H,S,M) = (26480, 16, 63, 16) #
| |DMA Mode = 0x84 4 #
| |Use NVRAM config info. #
| |RAID not configured! #
| |Hot-Plug function ready. #
+-----+
AZ:Move Cursor, ESC:Exit, Enter:Enter, Tab:Switch to Output Area
Connected 0:03:31 VT100 115200 8-N-1 SCROLL CAPS NUM Capture Print echo
```

Warning !

Unpredictable results will occur if firmware update is attempted during Host computer and Disk Array activity. All activity to the controller should be stopped before updating firmware.

2. Press "Y" to confirm the Update.

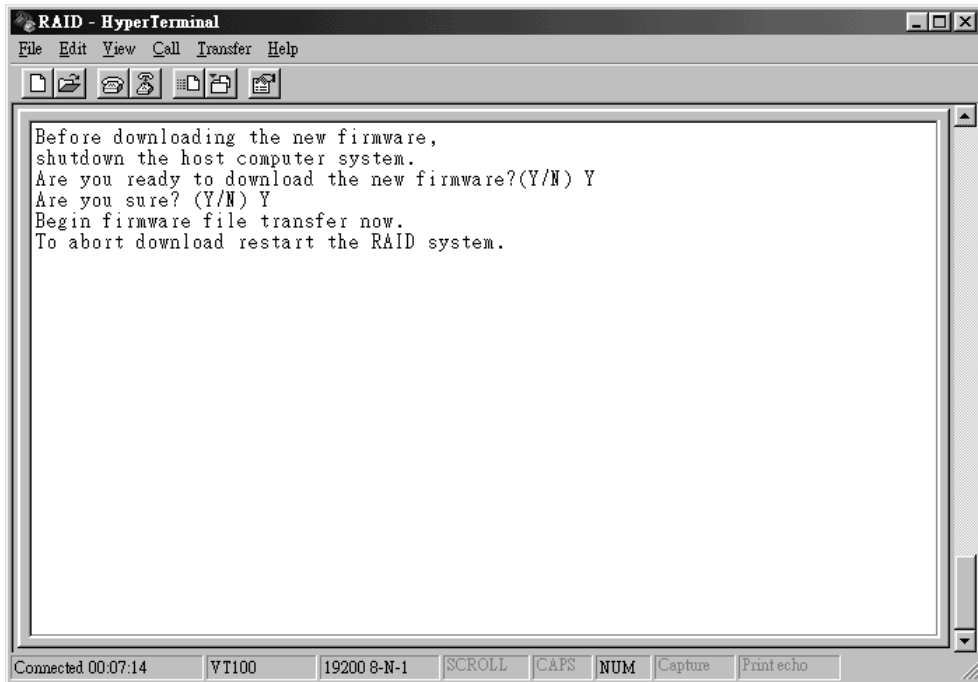

3. Select transfer " **Send Text File** " and press Enter.

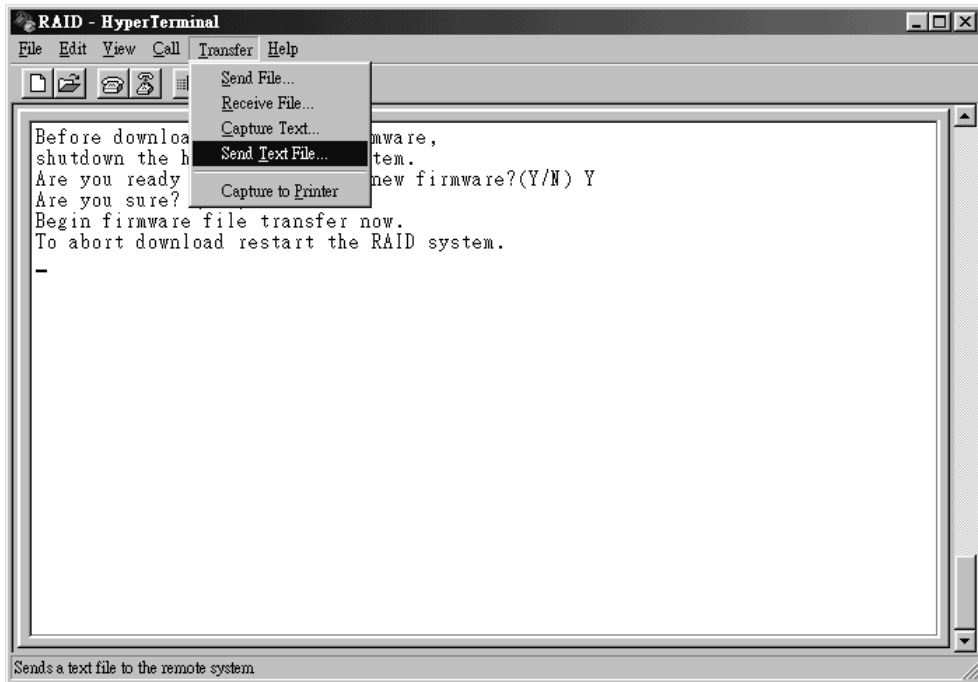

4. Locate the new Firmware file on your PC.

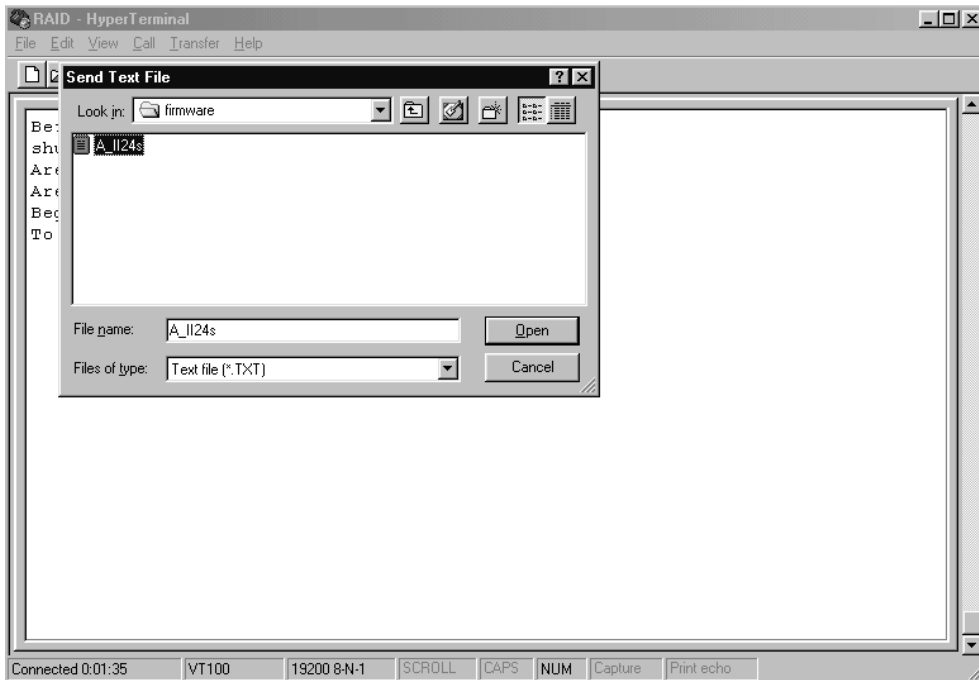

Advanced Information

5. Press "Y" to confirm to download the new firmware
and type "Go" to confirm the new firmware update.



```
RAID - HyperTerminal
File Edit View Call Transfer Help
Before downloading the new firmware,
shutdown the host computer system.
Are you ready to download the new firmware?(Y/N) Y
Are you sure? (Y/N) Y
Begin firmware file transfer now.
To abort download restart the RAID system.
00042C00
File transfer complete.
Checksum = 0xE061 : OK.
New firmware transfer complete.
Enter 'Go' to update the firmware. Go
Enter 'Go' to reconfirm.
Connected 00:22:20 VT100 19200 8-N-1 SCROLL CAPS NUM Capture Print echo
```

Advanced Information

6. Type "Go" to reconfirm and the firmware will begin to be reprogrammed.
7. After verifying, please **restart the Disk Array** to activate the new firmware.

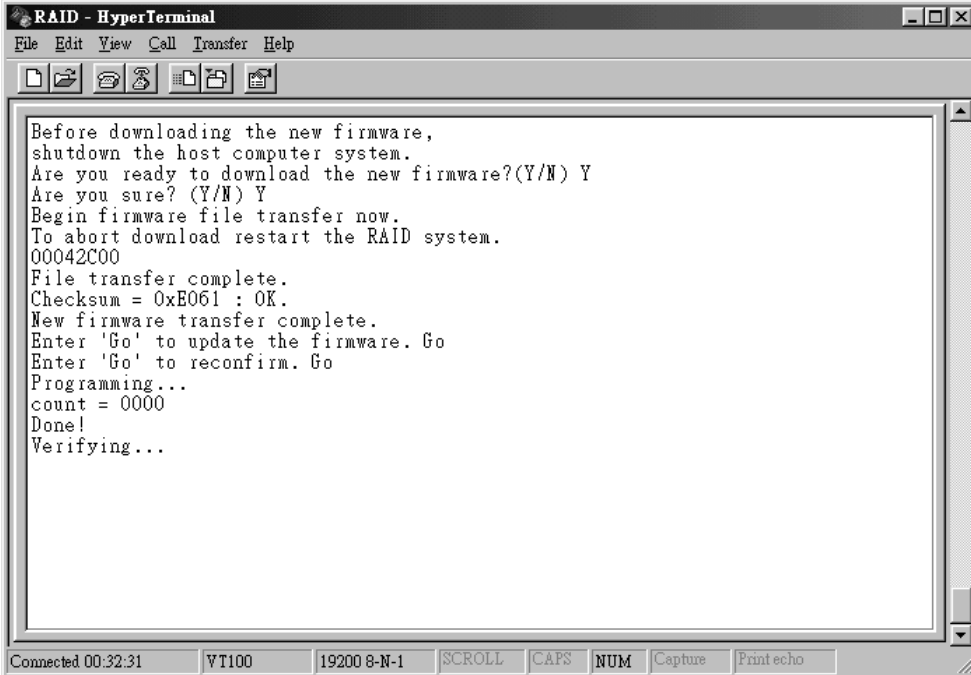

```
RAID - HyperTerminal
File Edit View Call Transfer Help
Before downloading the new firmware,
shutdown the host computer system.
Are you ready to download the new firmware?(Y/N) Y
Are you sure? (Y/N) Y
Begin firmware file transfer now.
To abort download restart the RAID system.
00042C00
File transfer complete.
Checksum = 0xB061 : OK.
New firmware transfer complete.
Enter 'Go' to update the firmware. Go
Enter 'Go' to reconfirm. Go
Programming...
count = 0000
Done!
Verifying...
```

Connected 00:32:31 VT100 19200 8-N-1 SCROLL CAPS NUM Capture Print echo

Advanced Information

3. Select the " Save & Restart " function and press " Enter " to save and activate your selection.

```
RAID - HyperTerminal
File Edit View Call Transfer Help
AZ:Move Cursor, ESC:Exit, Enter:Enter, Tab:Switch to Output Area
Please input key: ' '..'

+-----+
|-----+ Monitor Utility v2.5I +-----+
|-----+ LCD +-----+ OUTPUT +-----+
|-----+ No Configuration | (C,H,S,M) = (26480, 16, 63, 16)
|-----+ MENU +-----+ DMA Mode = 0x84 4
|+--Main Menu---+ |DISK: #4 ST313620A
||Re-Config RAID| | (C,H,S,M) = (26480, 16, 63, 16)
||RAID Level | |DMA Mode = 0x84 4
||Hot Spare Disk| |DISK: #3 ST313620A
||Set SCSI ID | | (C,H,S,M) = (26480, 16, 63, 16)
||Termination | |DMA Mode = 0x84 4
||Set Password | |DISK: #2 ST313620A
||Save & Restart| | (C,H,S,M) = (26480, 16, 63, 16)
||On+ve & Restart---+ |DMA Mode = 0x84 4 #
||Up| NO | |DISK: #1 ST313620A #
|+--| YES | | (C,H,S,M) = (26480, 16, 63, 16) #
| +-----+ |DMA Mode = 0x84 4 #
| |DISK: #7 ST313620A #
| | (C,H,S,M) = (26480, 16, 63, 16) #
| |DMA Mode = 0x84 4 #
| |Use NVRAM config info. #
| |RAID not configured! #
| |Hot-Plug function ready. #
+-----+
AZ:Move Cursor, ESC:Exit, Enter:Enter, Tab:Switch to Output Area

Connected 0:03:02 VT100 115200 8-N-1 SCROLL CAPS NUM Capture Print echo
```