

Chapter 4 : " Advanced Information "

This chapter describes more information about your Disk Array. The following items are describes in detail.

- Memory Expansion
- RAID Controller
- Updating Firmware
- Capacity Expansion (On-Line Expand)

Advanced Information

Memory Expansion

Your Disk Array comes with 64MB of memory that is expandable to a maximum of 512MB.

These expansion memory module can be purchased from your dealer.

- Memory Type : 3.3V PC100/133 SDRAM 144pin DIMM.
- Memory Size : Supports 144pin DIMMs of 64MB, 128MB, 256MB or 512MB.
- Height : 1.15 Inches (29.2 mm).

64MB	8(8Mx8), 8(4Mx16) or 4(8Mx16)
128MB	16(8Mx8), 8(16Mx8), 8(8Mx16) or 4(16Mx16)
256MB	16(16Mx8), 8(32Mx8) or 8(16Mx16)
512MB	16(32Mx8)

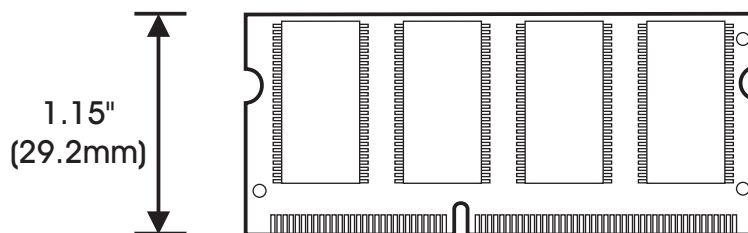

- Installing Memory Modules :

1. Unscrew & Remove cover

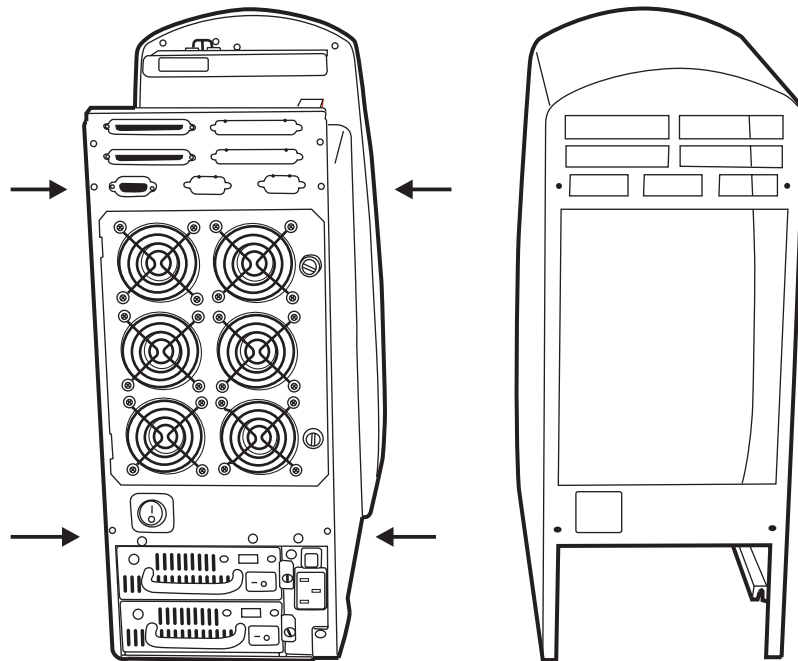

Unscrews

Figure : Remove Cover

2. Install the memory

- a. The DIMM memory modules will only fit in one orientation.
- b. Press the memory module firmly into socket from a 45 degree angle, make sure that all the contacts are aligned with the socket.
- c. Push the memory module forward to a horizontal position.

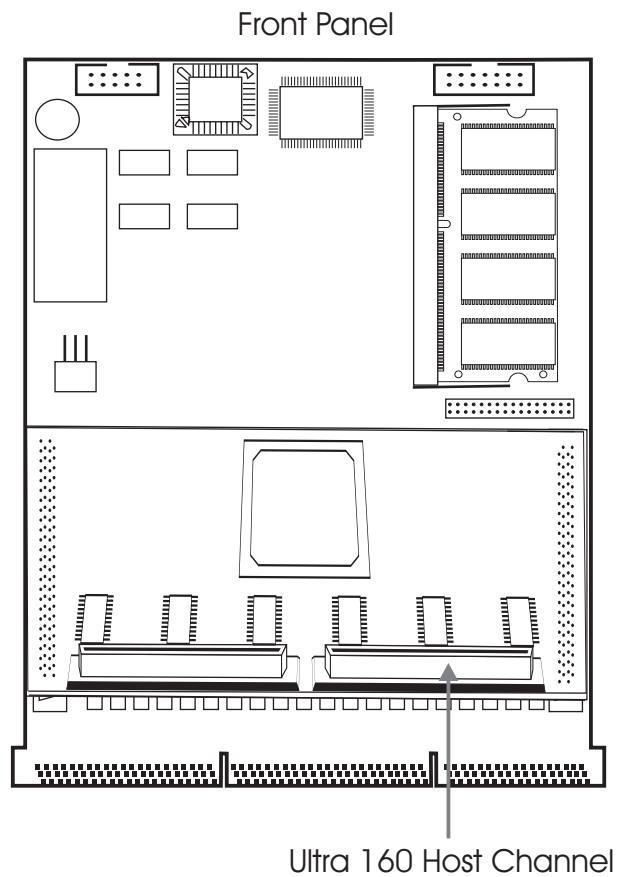
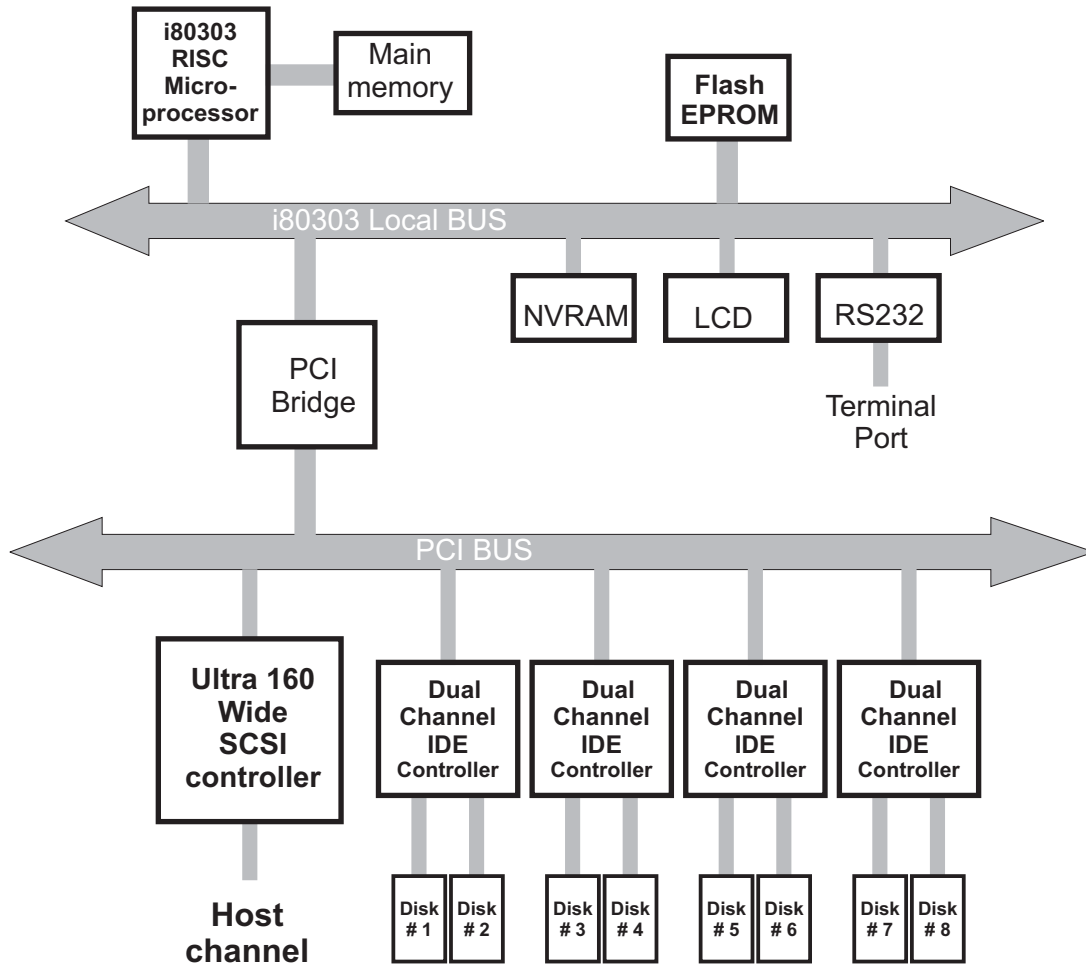

Figure : Controller

Advanced Information

Disk Array Controller Block Diagram



Advanced Information

Updating Firmware

1. Setup your VT100 Terminal

Please configure the VT100 terminal setting to the values shown below :

VT100 terminal (or compatible) set up

Connection	Serial Port (COM1 or COM2)
Protocol	RS232 (Asynchronous)
Cabling	Null-Modem cable
Baud Rate	115,200
Data Bits	8
Stop Bit	1
Parity	None

Setup VT100 Terminal

Example : Setup VT100 Terminal in Windows® 95

Step 1.

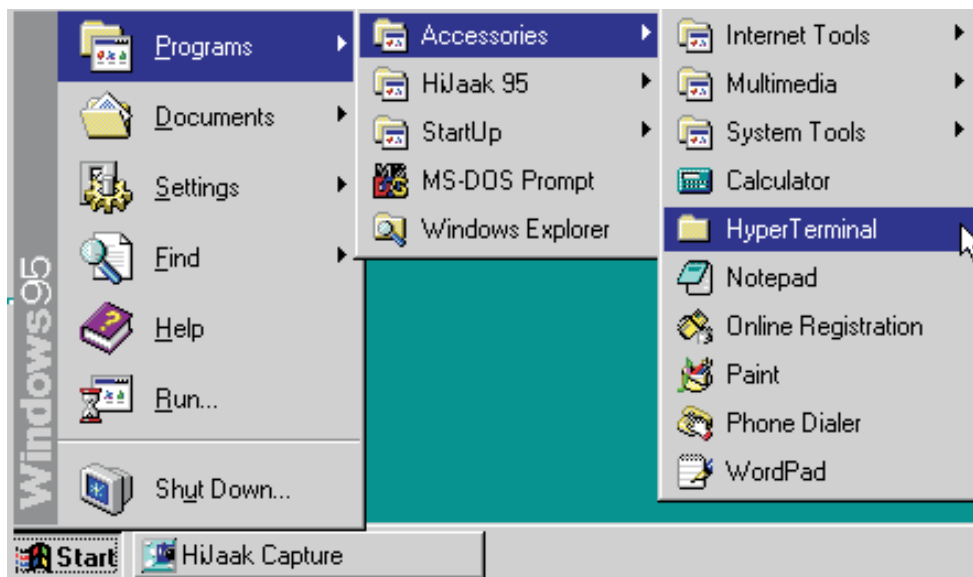

Advanced Information

Step 2.

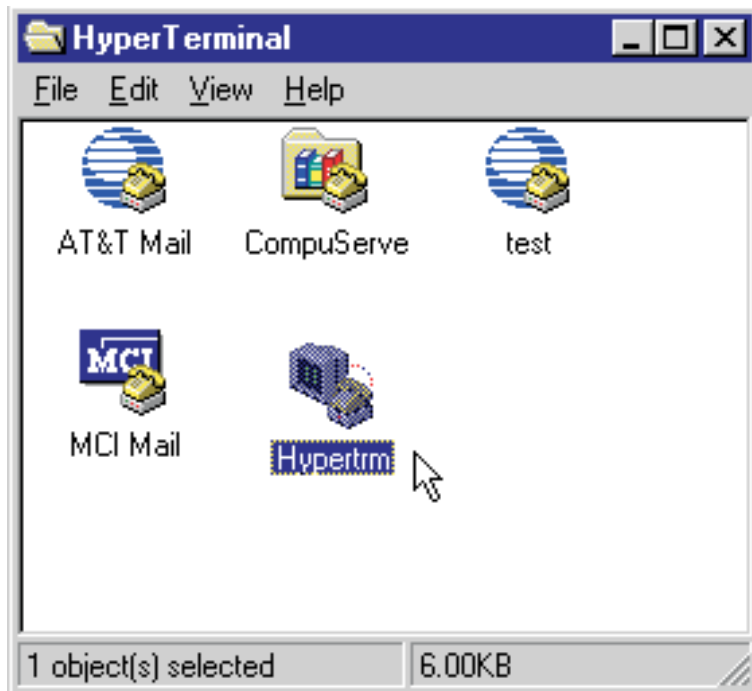

Advanced Information

Step 3. Enter a name for your Terminal.

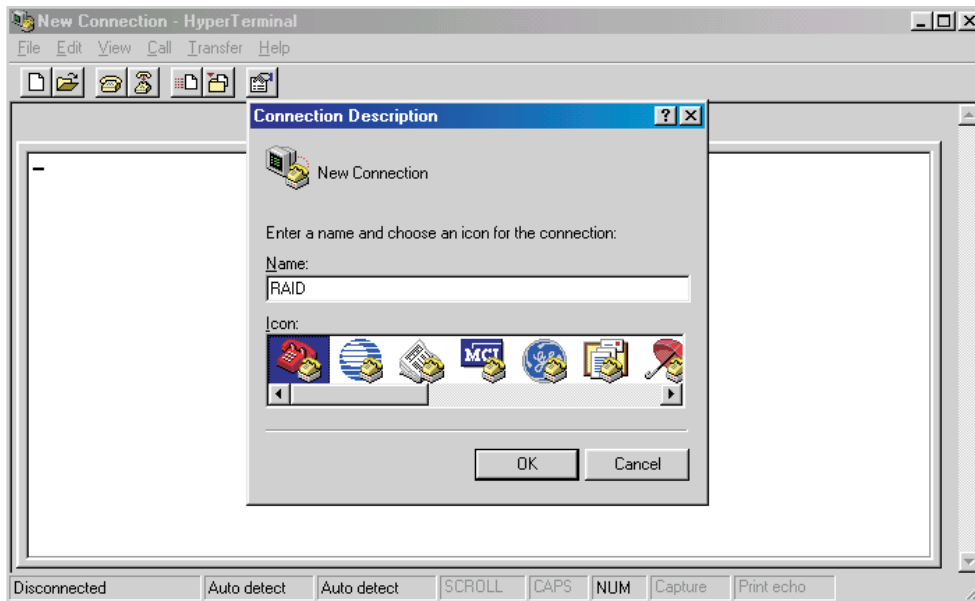

Advanced Information

Step 4. Select a connecting port in your Terminal.

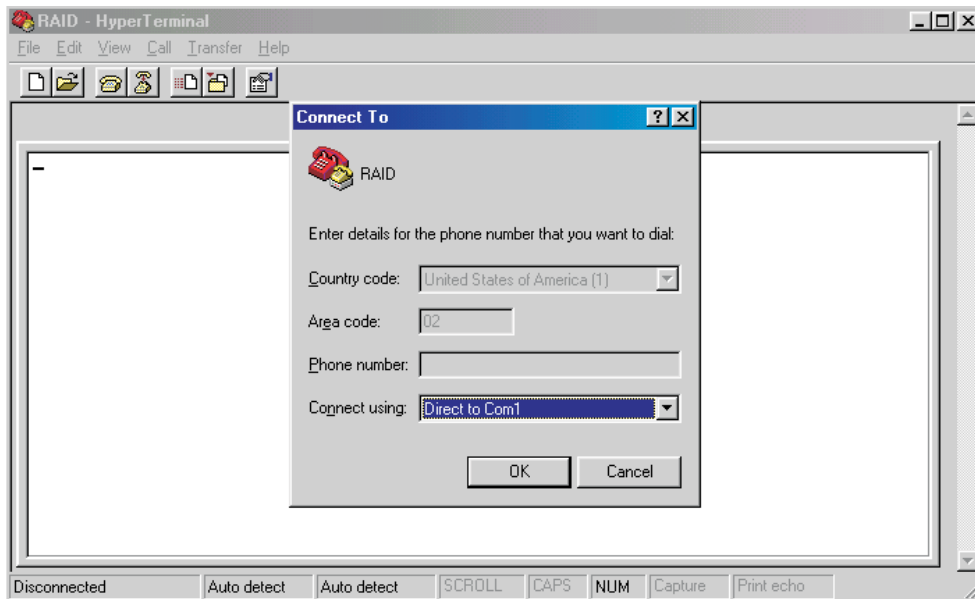

Advanced Information

Step 5. Port parameter settings

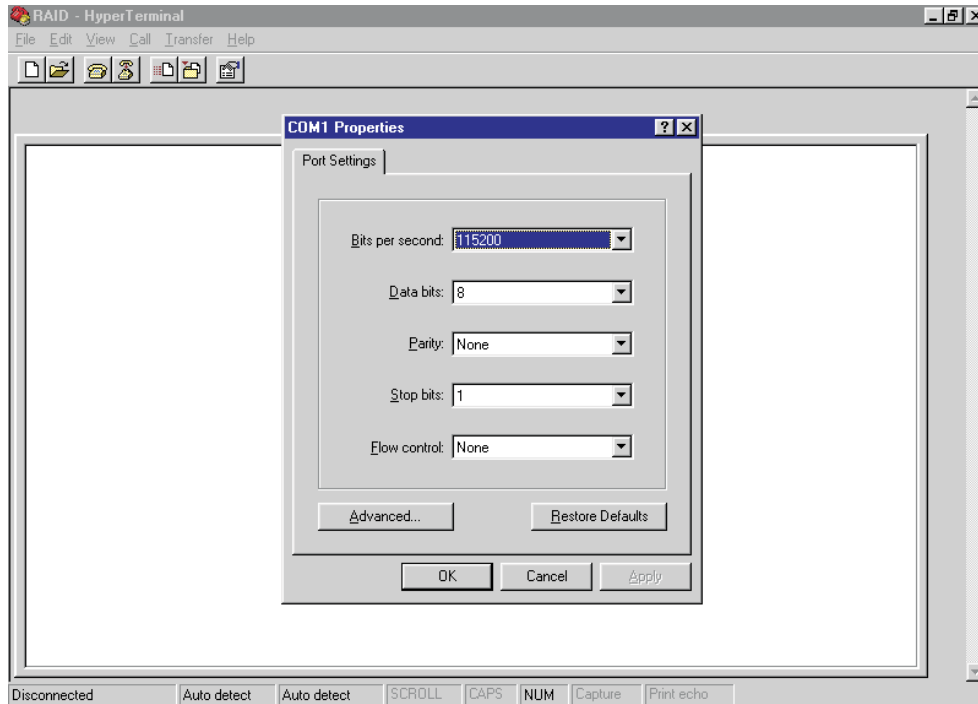

Advanced Information

Step 6.

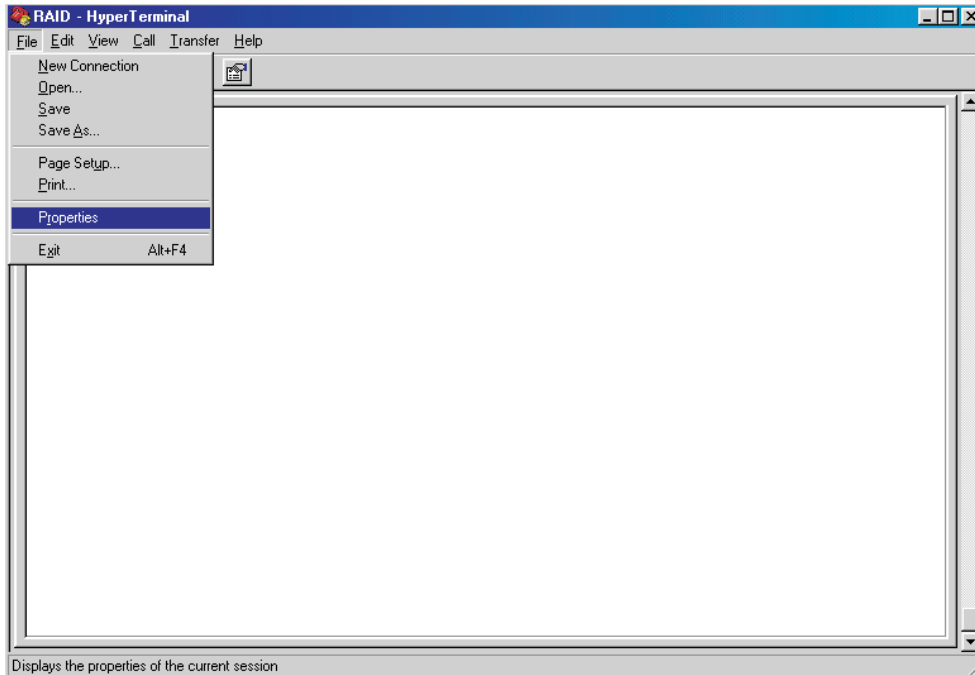

Advanced Information

Step 7. Select emulate VT100 mode

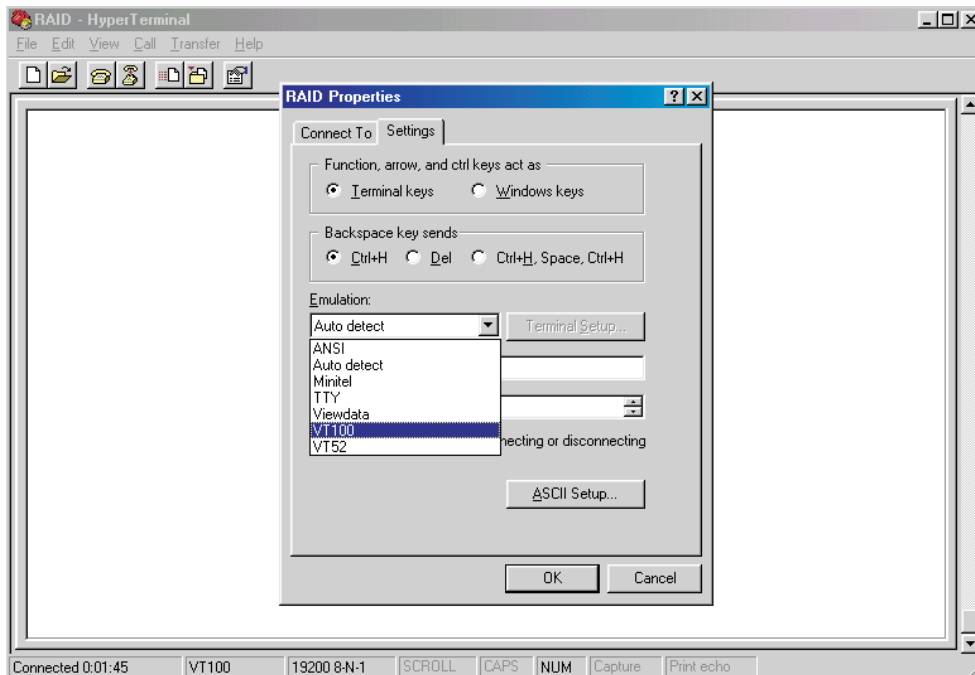

After you have finished the VT100 Terminal setup, you may restart your Disk Array and press " Ctrl + D " keys (in your Terminal)to link the Disk Array and Terminal together.

Press **Ctrl** + **D** to display the disk array Monitor Utility screen on your VT100 Terminal.

Advanced Information

2. Press " Y " to download the new firmware and press " Y " again to confirm the Update.

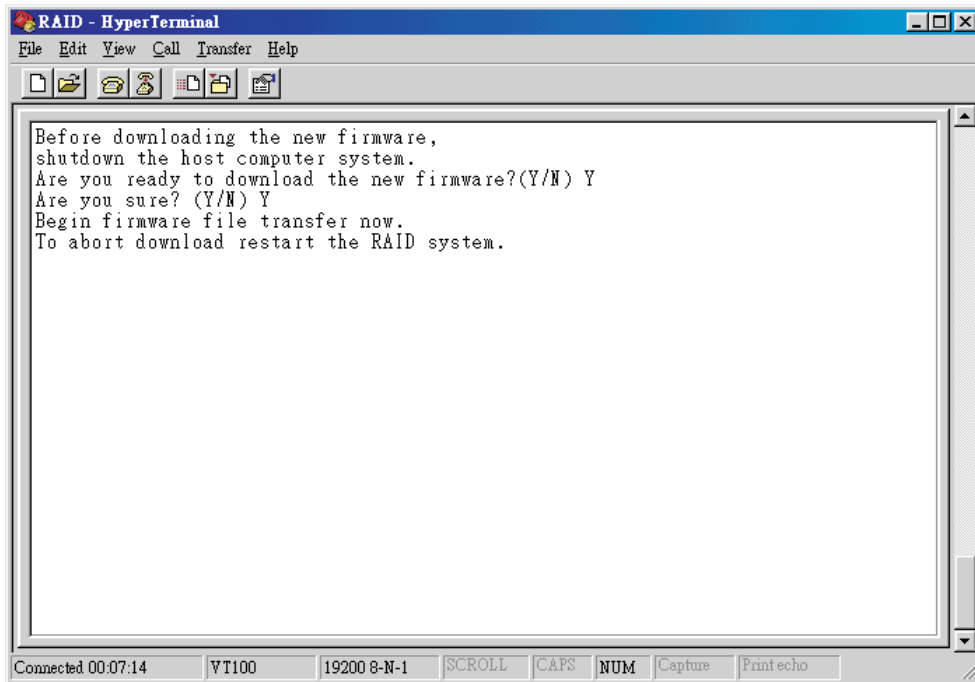

Advanced Information

3. Select transfer " Send Text File " and press Enter.

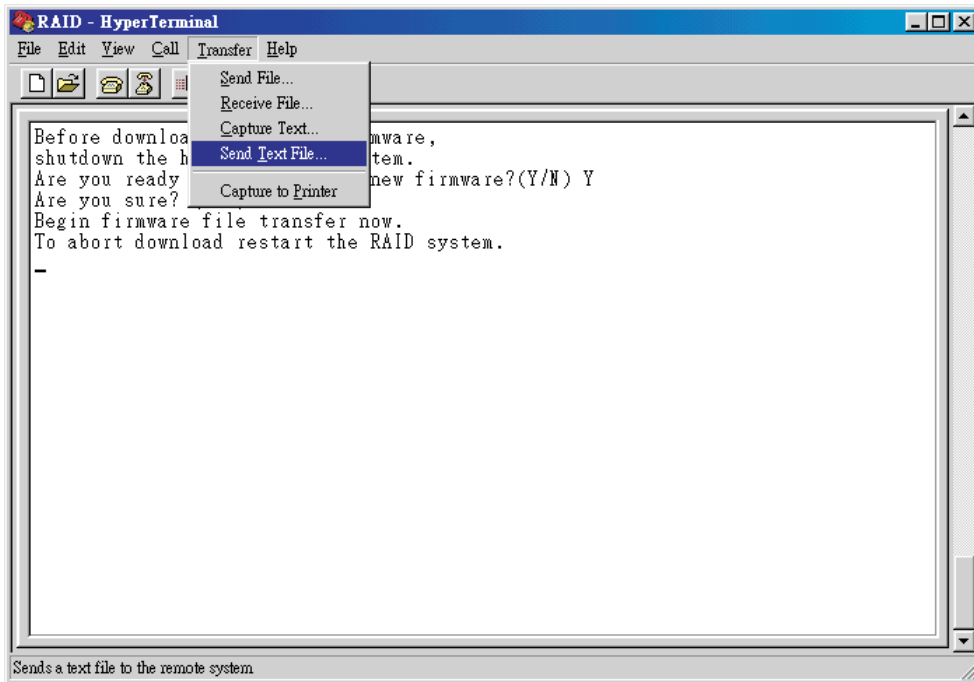

Advanced Information

4. Locate the new Firmware file on your PC.

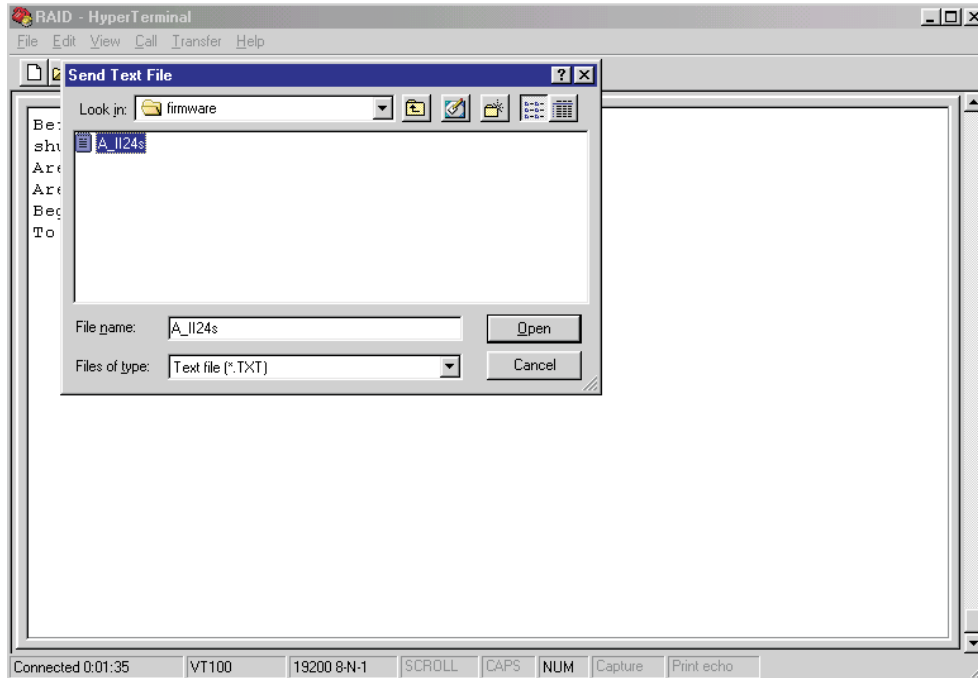

Advanced Information

5. Press "Go" to confirm to download the new firmware.

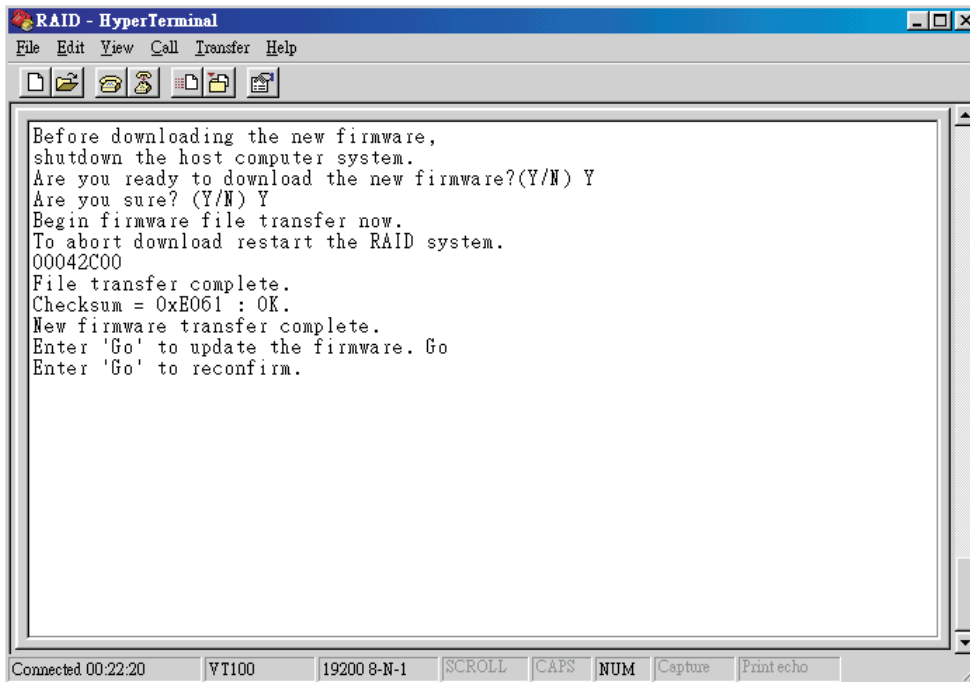

```
RAID - HyperTerminal
File Edit View Call Transfer Help
Before downloading the new firmware,
shutdown the host computer system.
Are you ready to download the new firmware?(Y/N) Y
Are you sure? (Y/N) Y
Begin firmware file transfer now.
To abort download restart the RAID system.
00042C00
File transfer complete.
Checksum = 0xE061 : OK.
New firmware transfer complete.
Enter 'Go' to update the firmware. Go
Enter 'Go' to reconfirm.
Connected 00:22:20 VT100 19200 8-N-1 SCROLL CAPS NUM Capture Print echo
```

Advanced Information

6. Type "Go" to reconfirm and the firmware will begin to be reprogrammed.
7. After verifying, please **restart the Disk Array** to activate the new firmware.

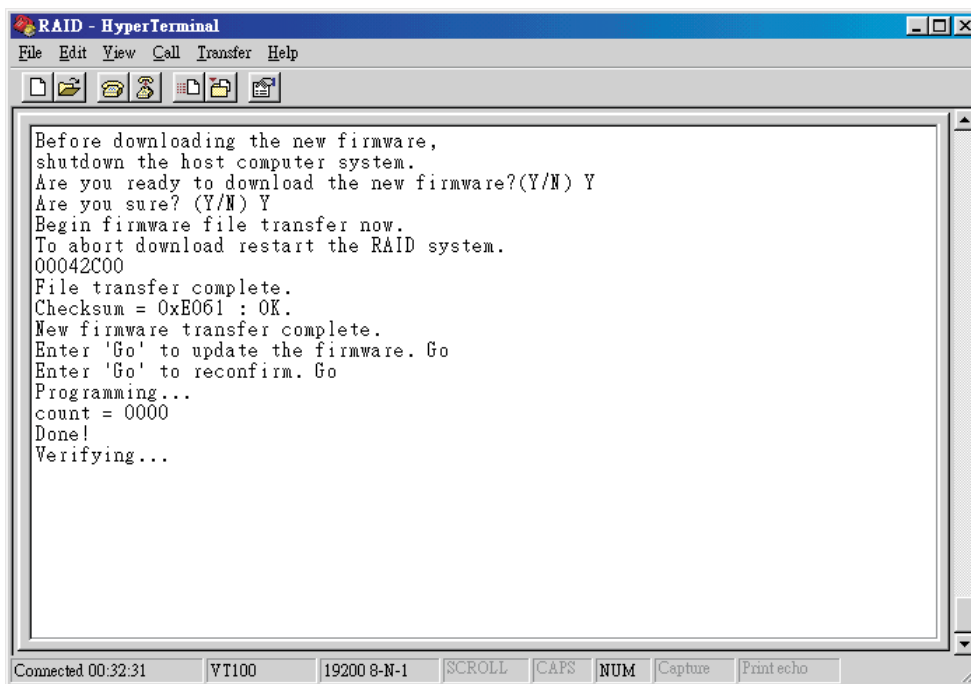

```
RAID - HyperTerminal
File Edit View Call Transfer Help
Before downloading the new firmware,
shutdown the host computer system.
Are you ready to download the new firmware?(Y/N) Y
Are you sure? (Y/N) Y
Begin firmware file transfer now.
To abort download restart the RAID system.
00042C00
File transfer complete.
Checksum = 0xE061 : OK.
New firmware transfer complete.
Enter 'Go' to update the firmware. Go
Enter 'Go' to reconfirm. Go
Programming...
count = 0000
Done!
Verifying...
```

Connected 00:32:31 VT100 19200 8-N-1 SCROLL CAPS NUM Capture Printecho

Advanced Information

Capacity Expansion

The RAID capacity can be expanded by add one or more Disk Drive into the existing RAID group and properly setup procedures.

1. Add new HDD into the RAID system.
2. Configuration through the RS-232 Terminal mode, move the cursor to " **On-Line Expand** " and " **Enable** " and press " **Enter** " to confirm it.

(If you have not add any new HDD into the RAID group the " **Enable** " item will not show up.)

```
RAID - HyperTerminal
File Edit View Call Transfer Help
AZ:Move Cursor, ESC:Exit, Enter:Enter, Tab:Switch to Output Area
Please input key: '...'

----- Monitor Utility v1.10a -----
|----- LCD -----|----- OUTPUT -----| | |
| OOOOOSSS RSID:0 | DISK: #7 IBM-DTLA-307075 |
|----- MENU -----| (C,H,S,M) = (148945, 16, 63, 16) |
|+-Main Menu-+-+ | DMA Mode = 0x84 4 |
| |Re-Config RAID| | DISK: #1 IBM-DTLA-307075 |
| |RAID Level | | (C,H,S,M) = (148945, 16, 63, 16) |
| |Hot Spare Disk| | DMA Mode = 0x84 4 |
| |Set SCSI ID | | DISK: #6 IBM-DTLA-307075 |
| |Set Password | | (C,H,S,M) = (148945, 16, 63, 16) |
| |Save & Restart| | DMA Mode = 0x84 4 |
| |On-Line Expand| | DISK: #4 IBM-DTLA-307075 |
| |Up+On-Line Expand-+ | (C,H,S,M) = (148945, 16, 63, 16) |
| |Ad| ENABLE | DMA Mode = 0x84 4 | #
|-----+-----+ | DISK: #2 IBM-DTLA-307075 | #
| | (C,H,S,M) = (148945, 16, 63, 16) | #
| | DMA Mode = 0x84 4 | #
| | Disk config info found. | #
| | Use NVRAM config info. | #
| | (RAID5): Stripe = 64 | #
| | RAID Member: Disk(12345) | #
| | Hot-Plug function ready. | #
|-----+-----+
AZ:Move Cursor, ESC:Exit, Enter:Enter, Tab:Switch to Output Area
Connected 0:27:20 VT100 115200 8-N-1 SCROLL CAPS NUM Capture Print echo
```